

LT® SERIES



THE INTERNATIONAL® LT® SERIES.

**MAXIM**  
TRUCK & TRAILER

1-888-242-6126



**THE INTERNATIONAL® LT® SERIES  
DELIVERS EVERYTHING YOU ASKED  
FOR IN A DRIVER'S TRUCK.**

**LT**  
INTERNATIONAL



**THEN WE TOOK  
IT FURTHER.**



The LT® Series is the most driver-centric, fuel-efficient, uptime-focused truck we've ever delivered. Hundreds of driver recommendations shaped its design. From its ergonomically advanced interior and instrument panel to major enhancements in visibility and aerodynamics, the LT Series is designed and engineered to keep drivers comfortable and productive for the long haul. It's part of an uncompromising commitment to put our customers' business needs at the heart of every decision we make - a philosophy we call DriverFirst™.



## AN LT SERIES CONFIGURATION FOR EVERY APPLICATION.



Day Cab

56" Low Roof Sleeper

56" Hi-Rise Sleeper\*

73" Sky-Rise Sleeper

73" Hi-Rise Sleeper

\* Shown with optional sun visor



## DRIVERFIRST™ - FROM CONCEPT TO REALITY.

From the very beginning, priority #1 for the LT Series was to design a truck that drivers would really want to drive. To achieve this goal, we turned to the people who know driving best - real truck drivers.

These professionals gave us honest, priceless input over numerous research sessions and driver clinics. Then we set about redesigning, fine-tuning and retesting until drivers agreed, "this is the truck I've always wanted to drive."

That's how the LT Series became the most driver-centric truck on the road today. With more intuitive controls, enhanced visibility, a quieter cab, critical information at your fingertips and dozens of other smart features that help keep a driver comfortable and in control over the long haul.

International also utilizes premium soft touch vinyl interior panels throughout the vehicle, which minimizes the need for hard to clean, odor and moisture trapping woven panels.





# DRIVERFIRST IN EVERY DETAIL.

Every detail inside the LT Series cab has been carefully designed, measured and clinic-tested to optimally benefit the driver. The gauges received numerous tests and refinements to optimize their readability, usability and positioning so key information and alerts are precisely where they need to be to view without distraction. The standard premium gauge cluster features a customizable digital display that lets drivers intuitively select the information they prefer in a variety of situations.



A customizable digital display in the premium gauge cluster provides a wealth of information for the driver, including:

- ▶ Real-time fuel economy
- ▶ Axle load\*
- ▶ Custom gauge settings\*
- ▶ Safety indicators\*
- ▶ Digital speedometer
- ▶ Tire pressure\*



Intuitive controls allow you to easily navigate between digital screens.

**Back Button** - navigate to previous page/sub category and then to main home screen

**Navigation Button** - navigate up and down to move within categories, navigate left or right to access the main menu and to move from one category to another

**OK/Reset Button** - select a highlighted category or hold for 3 seconds to reset the item

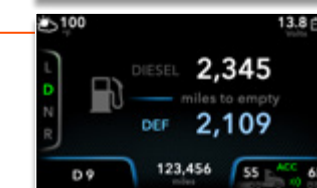

Driver safety is always a priority. That's why the LT Series includes standard Bendix® Wingman® Fusion™ system with collision mitigation technology, adaptive cruise control, lane departure warning (pictured here), over-speed alert and stationary vehicle braking. You can also select from a number of proven stand-alone safety systems to meet your specific needs. Bendix Wingman Advanced™ and Wabco OnGaurd ACTIVE™ are also available.

The color, illumination, legibility and even the type font and size of gauges is designed to deliver optimal viewing in varying light conditions, maximizing alertness and minimizing eye fatigue.

\* When added with optional feature code for required sensors.

## STALK SHIFTER



▶ The innovative stalk shifter is mounted on the steering column, allowing you to easily reach and smoothly operate shifting and engine braking while keeping your eyes on the road and your hands on the wheel.



# THE ART AND SCIENCE OF BOOSTING DRIVER PRODUCTIVITY.

The LT Series cab design included the meticulous study of over 500 interaction points between the driver and truck to address every possible aspect of ergonomics, from what a driver sees to the way he moves and how he can best handle virtually any situation – whether it’s climbing into the cab, cruising comfortably or getting a good night’s rest.



The LT<sup>®</sup> Series provides impressive forward and lateral visibility. Cab doors were designed with a lower bottom glass edge and no vent window seam for enhanced visibility and reduced blind spots.

DIRECT VISIBILITY

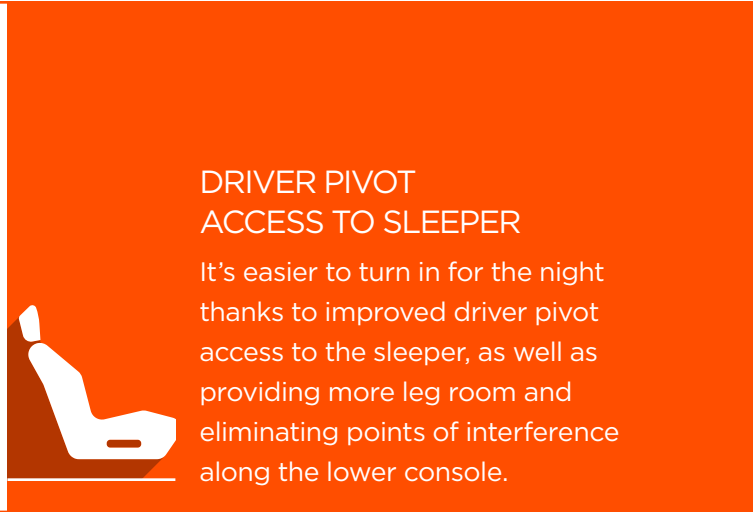

## DRIVER PIVOT ACCESS TO SLEEPER

It's easier to turn in for the night thanks to improved driver pivot access to the sleeper, as well as providing more leg room and eliminating points of interference along the lower console.

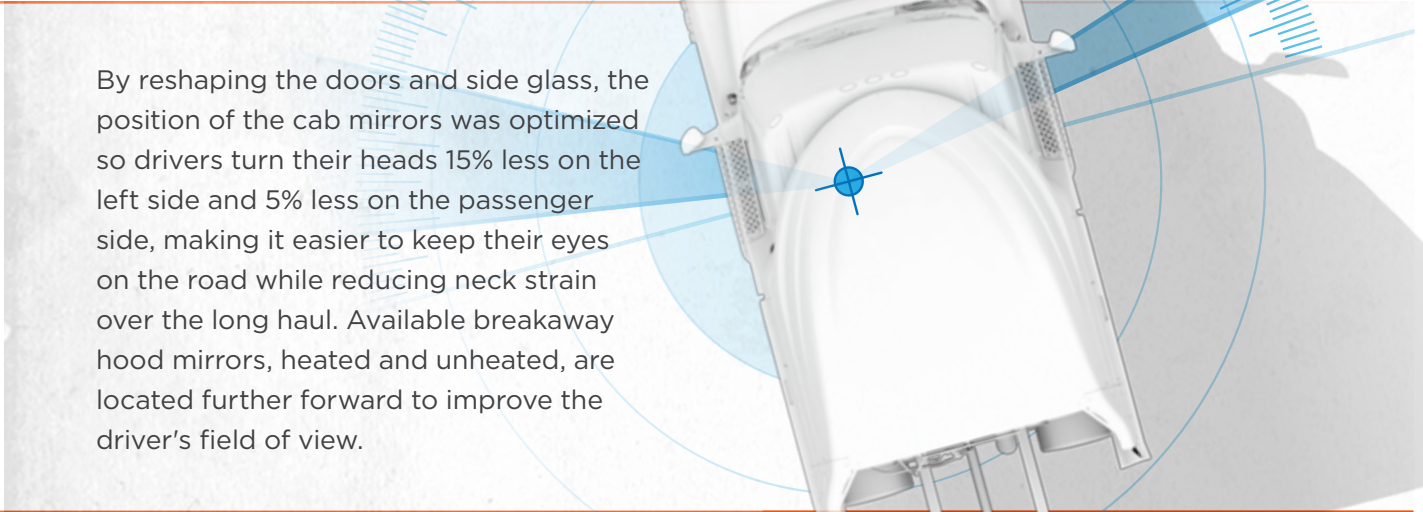

By reshaping the doors and side glass, the position of the cab mirrors was optimized so drivers turn their heads 15% less on the left side and 5% less on the passenger side, making it easier to keep their eyes on the road while reducing neck strain over the long haul. Available breakaway hood mirrors, heated and unheated, are located further forward to improve the driver's field of view.

INDIRECT VISIBILITY



Door panels are designed to help increase hip and elbow room while providing a more comfortable place to rest your arm. The full-grip interior handle makes doors easier to open and close, while large door pockets offer easier access to the driver's log or manifest.

Studies show that one of the largest causes of driver injury occurs from slip and falls while entering and exiting the cab. That's why we improved ingress and egress through wider opening doors, redesigned cab steps and grab handles that are precisely positioned for proper 3-point access.

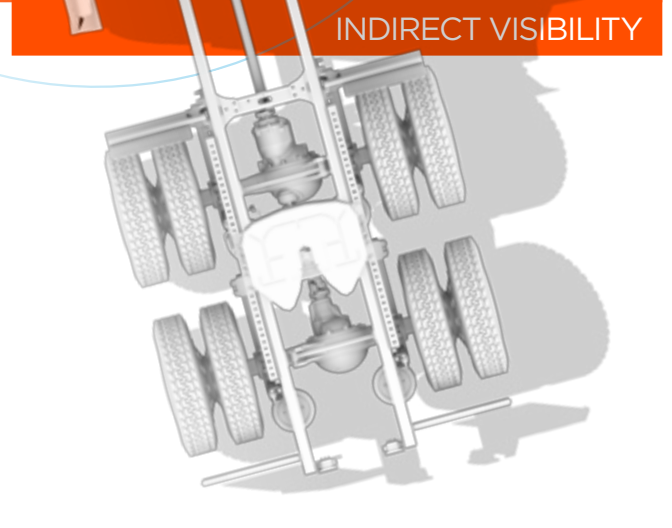
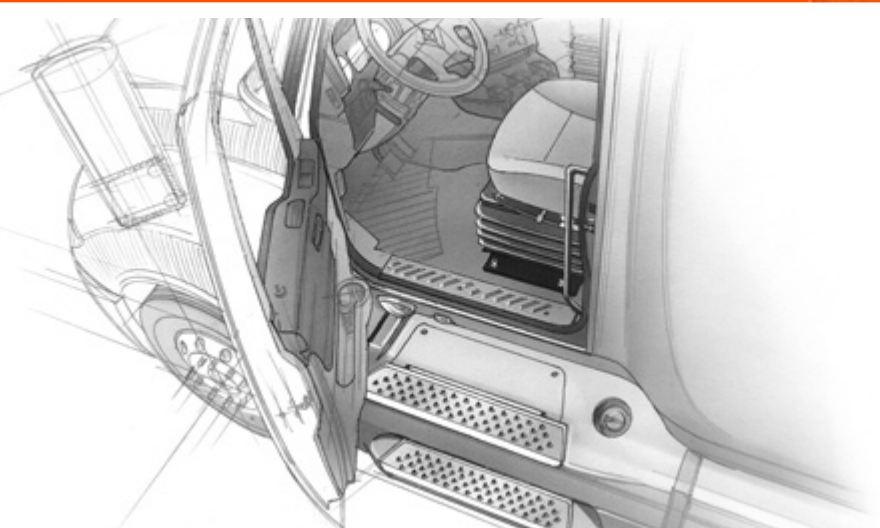



## KEEPING YOU ON THE ROAD TO PROFITABILITY.

Uptime is more than a word in the development of the LT Series, it's an unwavering commitment to deliver a truck that is as reliable and easy to service as the road is long.



- ▶ **Standard LED headlights and fog lights** deliver brighter light pattern and intensity. Tough polycarbonate lenses protect against breakage.
- ▶ **Driver controls and instrumentation** are based on robust industry-standard SAE J1939 electrical architecture, with gauge cluster and switches designed to keep drivers focused and maximize uptime.
- ▶ **Steering wheel control labels** are laser-etched through the thickness of the material and LED backlit for maximum durability and visibility.
- ▶ **Key interior fasteners** are exposed for more intuitive access and easier servicing.
- ▶ The available **automatic temperature control** maintains the selected cabin temperature for driver comfort.
- ▶ The **max defrost** feature in the HVAC system helps clear windows faster in colder climates, providing quicker, clearer visibility for increased uptime and less waiting.
- ▶ **Cab wiring** features a power distribution module that's located inside the cab, protected from the elements.
- ▶ The **single canister after-treatment system** is up to 60% smaller and 40% lighter than the system it replaces, with better heat management to help improve fuel economy and greater ash retention to stretch out time between service intervals. The system is also simplified for quicker servicing.

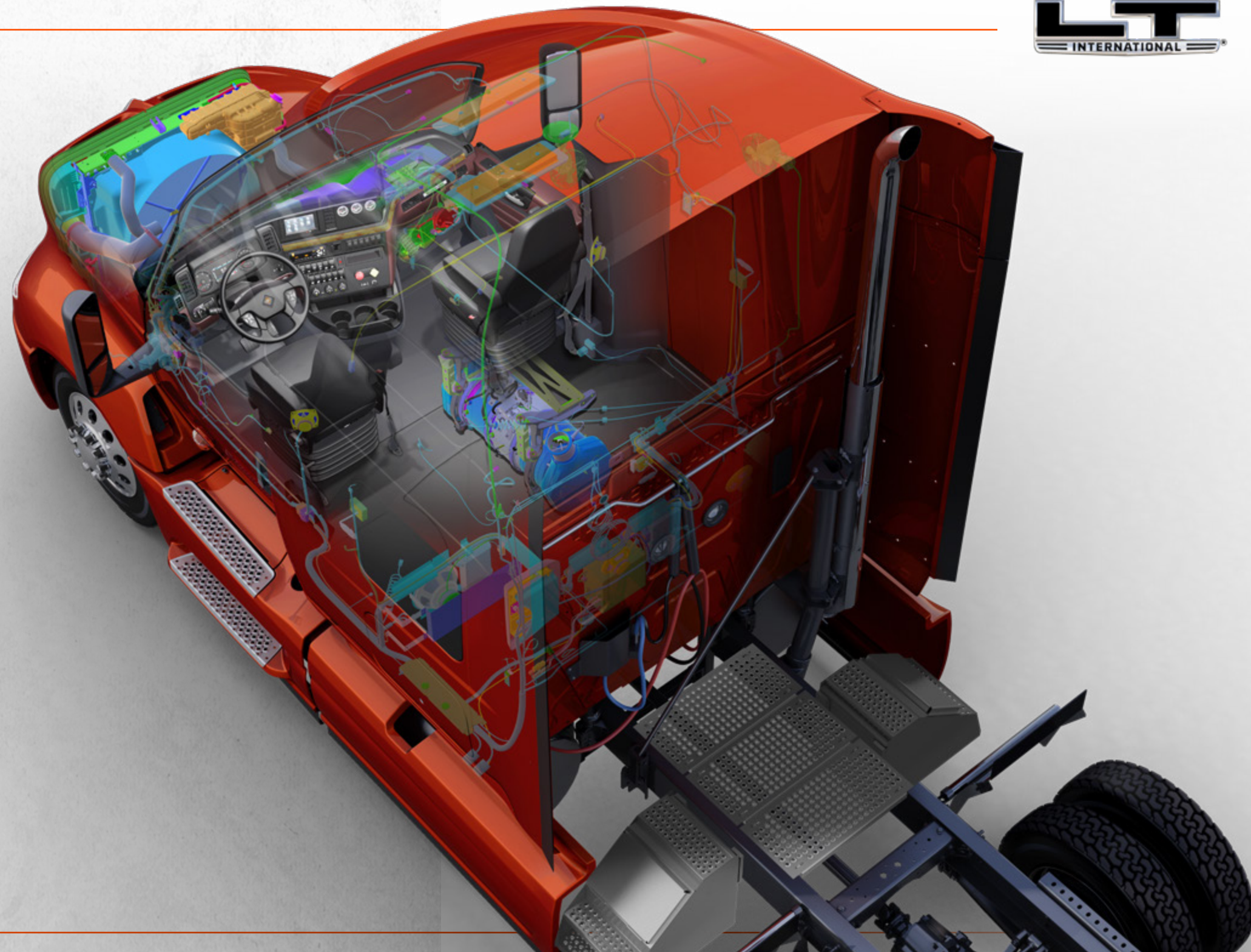



## SIMPLIFYING MAINTENANCE TO MAXIMIZE UPTIME.



The faster your truck can be serviced, the faster you're back on the road, meeting delivery schedules and boosting your profitability. The LT Series is designed and engineered to optimize uptime with industry-leading serviceability. All key service points under the hood, inside the cab and around the vehicle are ergonomically designed for easy access and servicing. Many components are engineered with longer intervals between required maintenance. And when you do need service, you can count on expert technicians and an extensive parts inventory from your International dealer.

▶ The LT Series hood opens wide and features gas strut control and torsion bar lift assist. The torsion bar reduces opening effort and enables the hood to be lifted with one hand. The gas strut helps dampen closing to prevent the hood from closing too quickly.

▶ The easily removable front grille and 3-piece bumper provide quick access to front components.  
▶ Lamp bulbs for turn signals and side markers are easy to access and can be replaced without tools.  
▶ Key components offer best-in-class accessibility, including cooling system thermostats, hoses, valves and switches.

▶ Translucent containers allow you to check fluid levels at a glance.  
▶ Tethered caps on most fluid containers prevent dropped or lost caps while refreshing fluids.



The commercial industry's largest service network of over 1,055 locations throughout North America, many with Saturday and Sunday availability, helps assure we're there where and when you need us. Count on the expertise of 10,786+ highly trained technicians operating out of 8,625+ service bays.







# THE LT® SERIES DELIVERS UP TO A 8.2% IMPROVEMENT IN FUEL EFFICIENCY.\*

With the LT Series, we wouldn't stop until we delivered the most fuel-efficient on-highway truck we've ever built. We spent hundreds of hours in the design studio and through an industry-best testing and development process, finessing every inch of the exterior to improve aerodynamic flow and optimize fuel efficiency. We trimmed weight without compromising quality. We also added a choice of advanced, fuel-efficient powertrains, state-of-the-art electronic controls systems and more technological advances designed to optimize every drop of fuel.

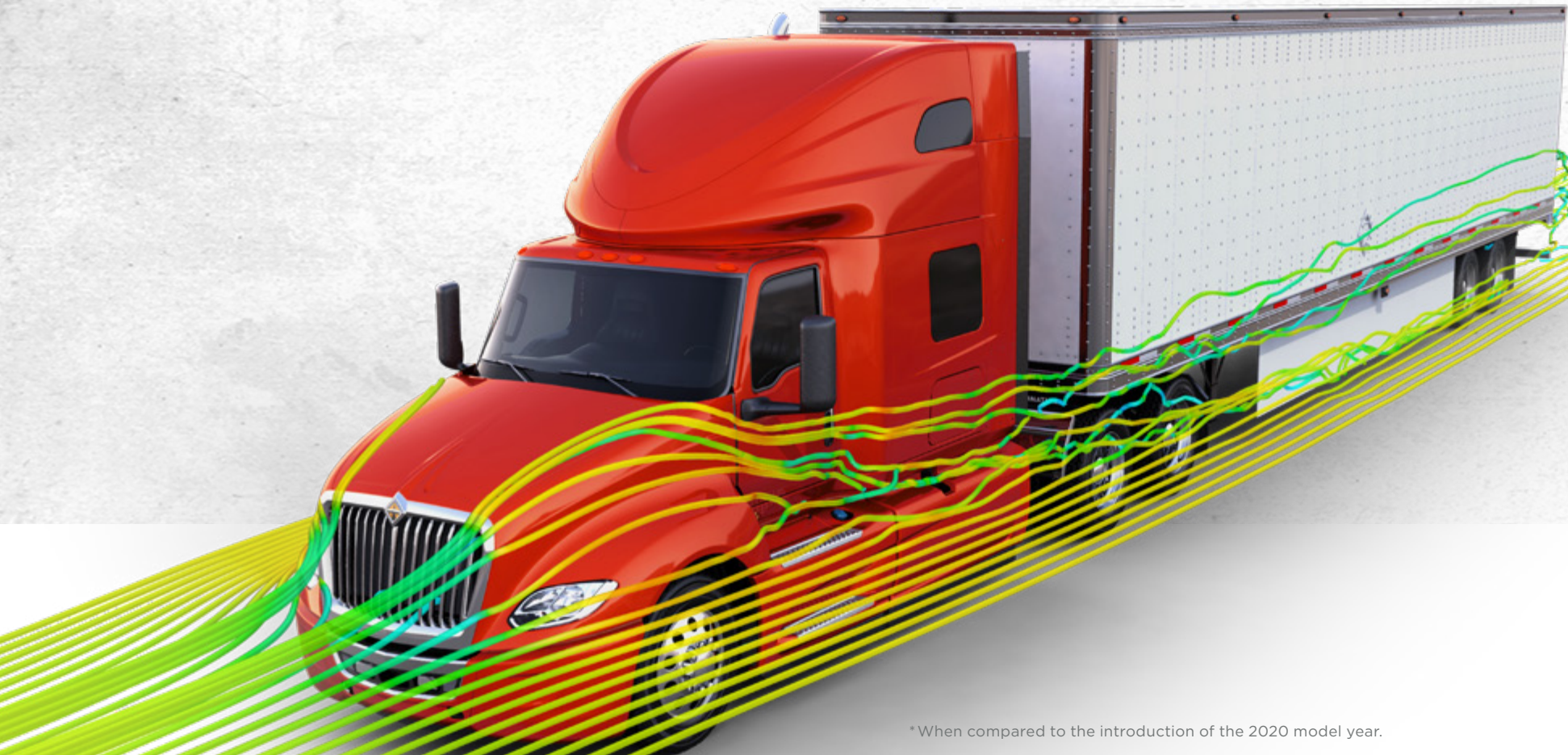

## EXTENSIVE AERODYNAMIC IMPROVEMENTS OPTIMIZE AIRFLOW AND REDUCE DRAG BOTH AROUND AND THROUGH THE LT SERIES

- ▶ Pedestal mirrors reduce drag and wind noise.
- ▶ The hood top and shoulder are redesigned to enhance air flow.
- ▶ The longer 125" BBC hood better directs and smooths out airflow around the cab.
- ▶ Aerodynamic fender shape optimizes airflow.
- ▶ 25" cab extenders close the gap between cab and trailer to limit air turbulence.
- ▶ An aero-enhanced 3-piece bumper and front wheel openings are contoured to minimize resistance.
- ▶ Chassis skirts and cab closeouts have been enhanced to reduce aerodynamic drag.
- ▶ The cooling module is sealed to smooth airflow under the hood.
- ▶ The front air dam design reduces drag by efficiently pushing air down, under and around the truck.

## THE WIND AVERAGED DRAG ADVANTAGE

In the real world, the wind almost always hits the truck at an angle, not head on. The LT Series was designed with this in mind and is a leader in Wind Averaged Drag. The higher the yaw angle, the better the LT Series performs against the competition.

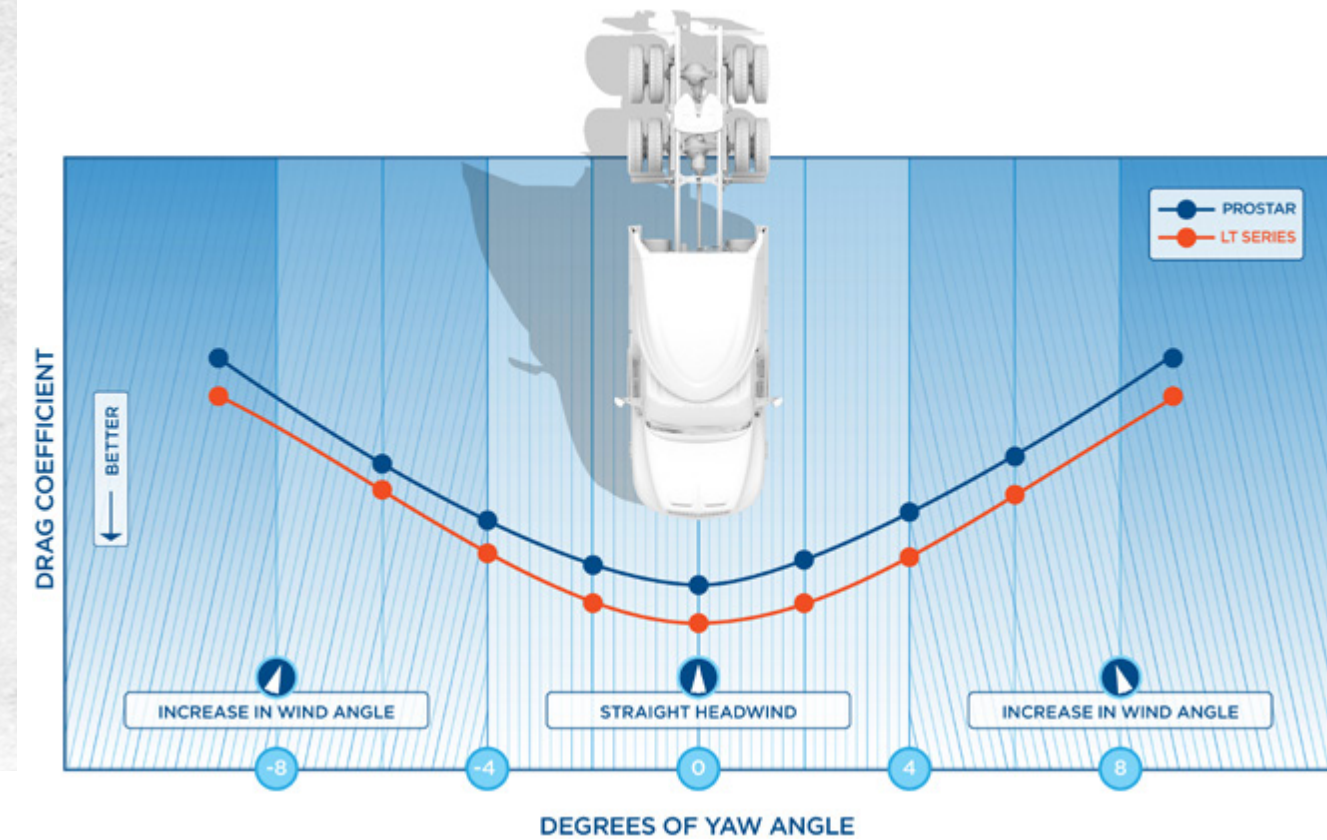

\*When compared to the introduction of the 2020 model year.

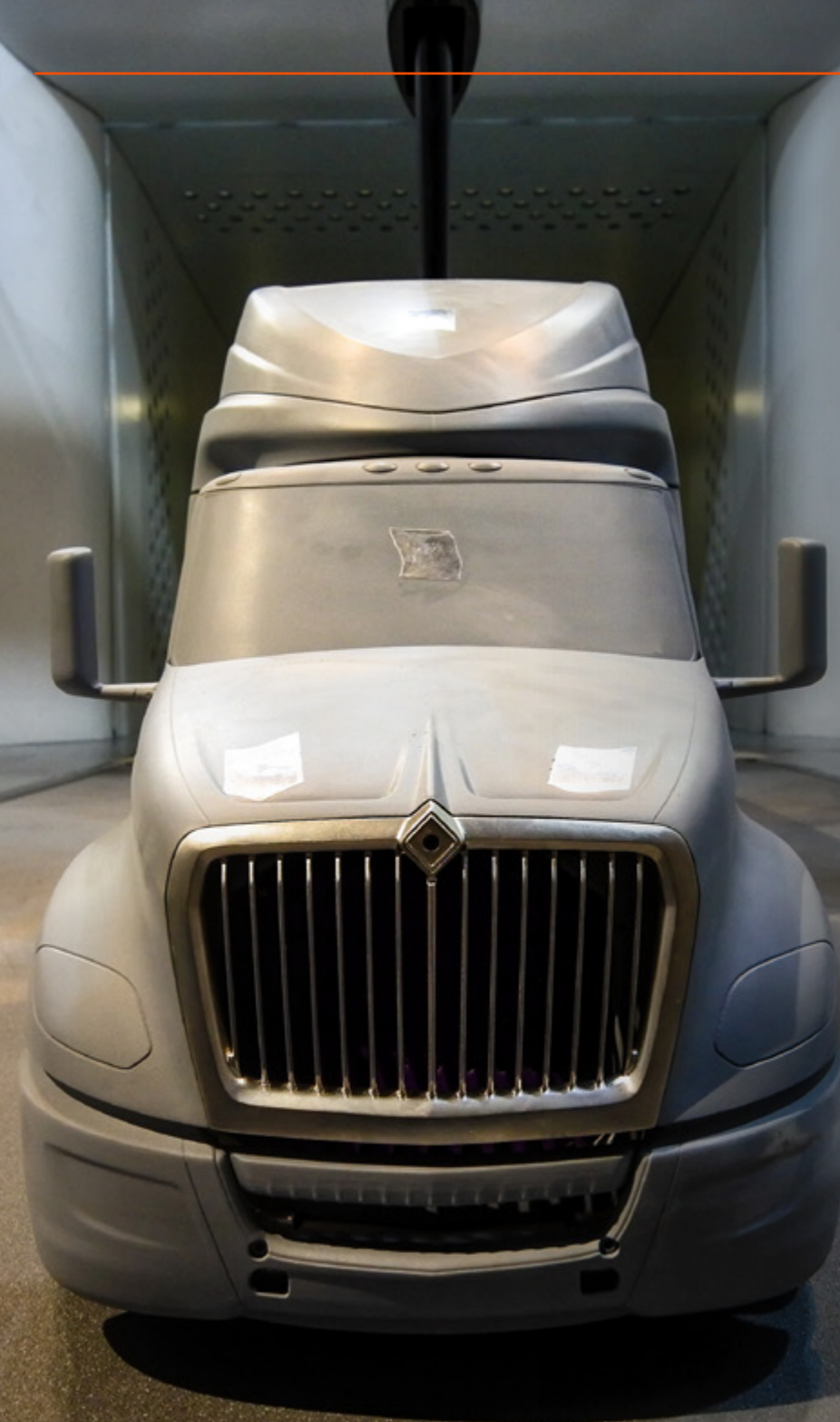

## PUTTING EFFICIENCY TO THE TEST.

The LT Series endured an industry-leading testing and retesting process – including wind tunnel testing of scale models, full-size trucks and coast-down testing – to assure every possible efficiency gain. With every 1% of aerodynamic improvement netting a .5% improvement in fuel economy, the LT Series delivers sizable fuel savings that you'll appreciate mile after mile, year after year.

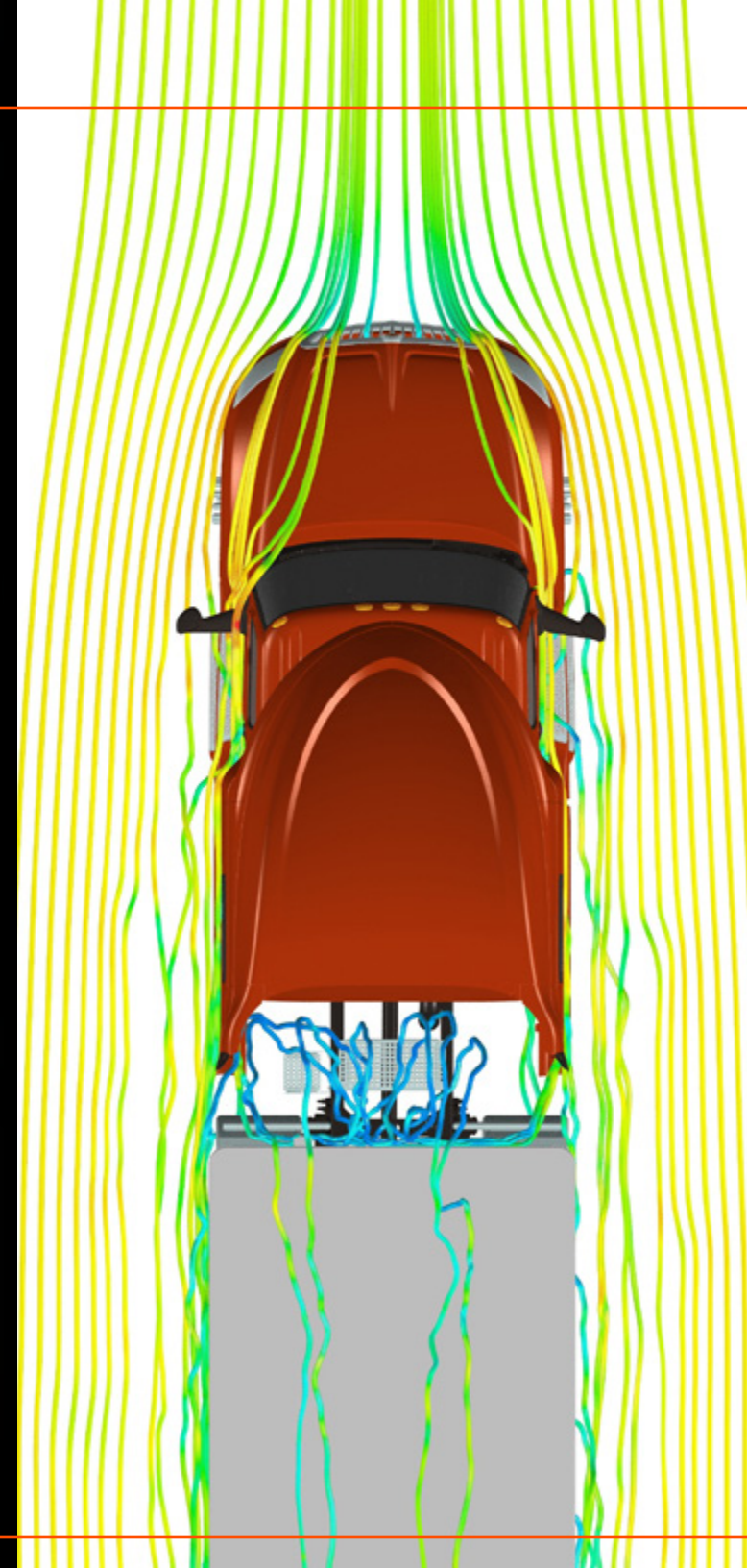

- ▶ Sophisticated electronic control systems use programmable parameters to optimize efficiency. Predictive cruise control recognizes when the vehicle should accelerate or decelerate before grades to avoid downshifts and minimize braking.
- ▶ A number of measures contribute to a weight reduction of over 400 lbs. vs. the previous model.\* The suspension and single canister after-treatment system were refined. Mounting hardware for the fuel tank and exhaust system has been streamlined. Everywhere you look, the LT Series is leaner and lighter while optimizing structural integrity.
- ▶ The LT Series uses state-of-the-art drivetrain and axle lubricants to reduce parasitic losses from friction, improving efficiency.

The LT Series has earned the prestigious U.S. Environmental Protection Agency (EPA) SmartWay® Designation.



\* Compared to a 2018 ProStar with a N13 engine.



The International A26 produces up to a 5% improvement in fuel economy over the engine it replaces due to numerous engineering enhancements that optimize combustion, reduce friction and increase the compression ratio.

The Cummins Eaton SmartAdvantage™ powertrain delivers a 2.2% improvement over the previous powertrain. Error-free, guess-proof shifting assures every driver in your fleet is as efficient as your best driver.

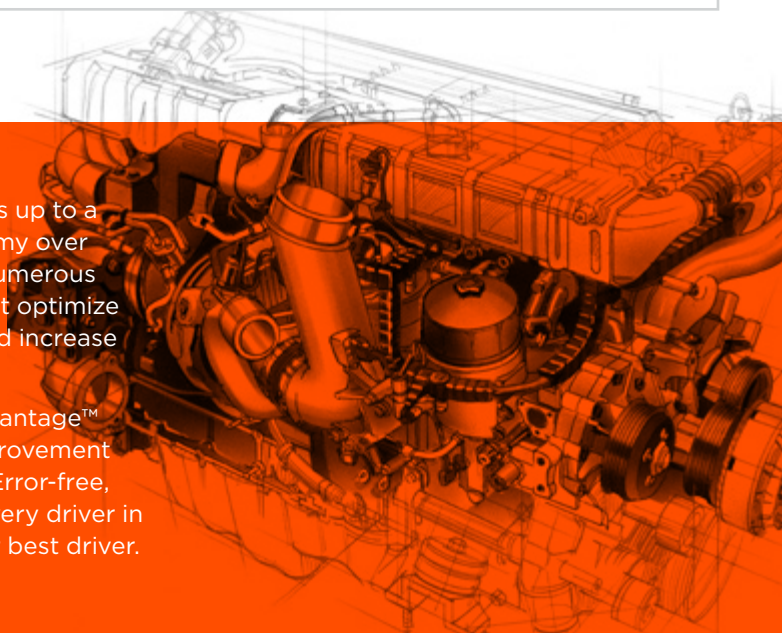



# INTERNATIONAL® A26

Designed exclusively for International® Trucks, the 2017 International A26 Engine offers premium performance in an advanced, fuel-efficient 12.4L design. The A26 produces up to 475 HP and 1750 lb.-ft. of torque from a design with a best-in-class dry weight of 2,299 lbs. and is 600-700 lbs. lighter than traditional big bore engines. It also features North America's first Class 7-8 Compacted Graphite Iron (CGI) crankcase design.

The A26's proven EGR system delivers outstanding reliability and maximum uptime. Combustion optimization, friction reduction, increased compression ratio, optimized cylinder head and calibration refinements deliver up to a 5% fuel economy improvement over the 2017 N13.

## Key Features

**Variable Geometry Turbocharger** - Titanium compressor wheel provides excellent longevity over competitive aluminum compressor wheels. Serviceable electronic actuator increases uptime and reduces service cost.

**Jacobs Engine Brake**® - Variable Geometry Turbocharger improves engine braking performance by up to 67% for increased braking power particularly at low- to mid-RPMs and higher altitudes.

**2500 Bar High Pressure Common Rail Fuel System** - Delivers maximum fuel injection pressure (36,300 psi) to reduce emissions and fuel consumption, with multiple injection events for smooth and quiet operation.

**Lightweight design** - Compacted Graphite Iron crankcase, shot peened aluminum flywheel housing, composite valve covers, and a hollow camshaft deliver a lightweight design, maximizing payload capacity.

**Cold starting** - Cold starting down to -40°F with available oil heater, coolant heater and cold start system with unaided cold starting down to 10°F for dependable starting in extreme climates or when plug-in heating isn't available.

LIGHTWEIGHT,  
QUIET AND  
EFFICIENT  
POWER



Horsepower [BHP @ RPM]	400 - 475 @ 1700
Torque [LB-FT @ RPM]	1550-1750 @ 975, 1450-1750 @ 1000
Gov. Speed [RPM]	1800

Engine Type	Diesel, 4-Cycle
Configuration	Inline 6-Cylinder
Displacement	12.4 L (758 cu. in.)
Bore & Stroke	4.96 in. & 6.54 in. (126 mm & 166 mm)
Compression Ratio	18.5:1
Aspiration	Variable Geometry Turbocharger
Combustion System	Direct Injection 2500 bar HPCR
Engine Lubrication	42 Quarts (40 L)
Total Engine Weight (Dry)	2,299 lbs. (1099 kg)
Valves	4 Valves Per Cylinder, Single Overhead Camshaft
B10 Design Life	1,200,000 mi (1,931,000 km)

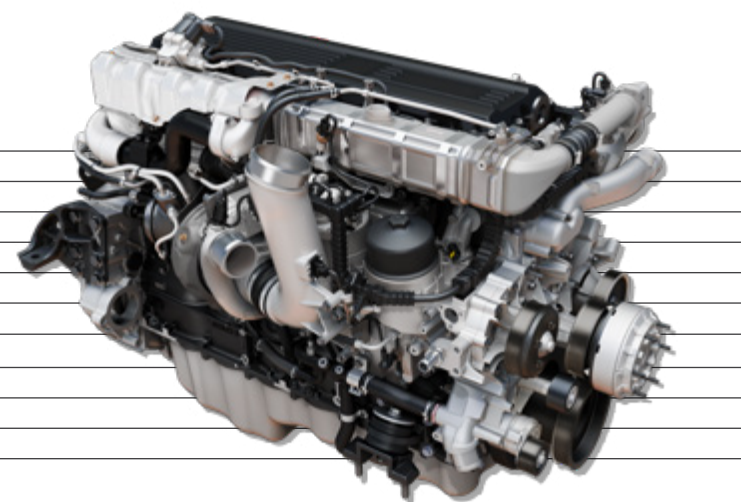

# CUMMINS® X15

Legendary Cummins® power in the X15 Productivity, Performance and Efficiency Series configurations. The X15 Efficiency Series produces up to 500 HP with advanced fuel-saving technology that includes dynamic electronic controls with ADEPT features, enhanced engine breathing and an optimized combustion process that leverages Cummins' proprietary VGT™ Turbo and XPI fuel system.

Utilizing the hardware sets of the Efficiency and Performance ratings, the Productivity Series provides customers the same cruise economy (up to 500 HP) as a comparable Efficiency Series product and the RPM flexibility out to 2000 RPM across all power ratings.

The X15 Performance Series generates up to 565 HP by upgrading virtually every critical component for enhanced air handling, faster throttle response and even stronger braking power at lower RPM.

New for 2020, the Cummins' next generation X15 Efficiency Series is designed to deliver up to 3.5%\* fuel economy improvement. Up to 5%\* fuel economy improvement can be achieved with new EX ratings, which focus on performance, drivability and fuel economy. The X15 engine will also deliver a 75,000 mi Oil Drain Interval (ODI), with additional savings obtained through an 80,000 mi ODI when using Valvoline Premium Blue or up to 100,000 mi ODI when participating in the Cummins OilGuard program.

## Key Features

**Variable Geometry Turbocharger** - Industry-leading proprietary design is four to six times stronger than previous designs for improved durability. The new design also includes a new impeller for rapid boost and improved braking.

**XPI Fuel System** - Delivers better performance at wider range of RPMs with multiple injection events to improve efficiency and provide smoother, quieter operation.

**Single High-Capacity ECM** - Efficient, single ECM management of the engine and after-treatment system for exceptional performance and fuel efficiency.

**Cummins Single Module Aftertreatment System** - A new flow-through design provides better heat management for improved efficiency and increased ash capacity for fewer cleanings. This integrated system is up to 40% lighter and 60% smaller than some two-part systems.

\* Per Cummins



Engine Type	Diesel, 4-Cycle
Configuration	Inline 6-Cylinder
Displacement	14.9 L (912 cu. in.)
Bore & Stroke	5.39 in. & 6.65 in. (137mm & 169mm)
Compression Ratio	Efficiency Series, 20:1   Performance Series, 18.9:1
Aspiration	Variable Geometry Turbocharger
Combustion System	Direct Injection XPI Fuel System
Engine Lubrication	56 Quarts (53 L)
Total Engine Weight (Dry)	2,961 (1,343 kg)
Valves	4 Valves per Cylinder, Single Overhead Camshaft
B50 Design Life	Cummins® engineers to a million mile design criteria

### PRODUCTIVITY SERIES

Horsepower [BHP @ RPM]	450 - 500 @ 1700
Torque [LB-FT @ RPM]	1650 - 1850 @ 950
Gov. Speed [RPM]	2000

### PERFORMANCE SERIES

Horsepower [BHP @ RPM]	505 - 565 @ 1600
Torque [LB-FT @ RPM]	1650 - 2050 @ 1150
Gov. Speed [RPM]	2000

### EFFICIENCY SERIES

Horsepower [BHP @ RPM]	400 - 500 @ 1500
Torque [LB-FT @ RPM]	1450 - 1850 @ 950
Gov. Speed [RPM]	1700



PROVEN MUSCLE  
FOR THE  
LONG HAUL



# AVAILABLE CONFIGURATIONS.



## DAY CAB

125" BBC

Local, Regional, Bulk and Specialized Applications



## 56" LOW ROOF SLEEPER

125" BBC

Regional Line Haul, Bulk, Flatbed and Specialized Applications



## 56" HI-RISE SLEEPER

125" BBC

Regional Line Haul and Owner Operator



## 73" HI-RISE SLEEPER

125" BBC

Long Haul Flatbed, Owner Operator and Specialized Applications



## 73" SKY-RISE SLEEPER

125" BBC

Long Haul, Owner Operator

# LT SERIES SPECIFICATIONS.



### BBC/BC

- ▶ 125"/ 50"

### Cab Configurations

- ▶ Day cab
- ▶ 56" Low Roof Sleeper
- ▶ 56" Hi-Rise Sleeper
- ▶ 73" Hi-Rise Sleeper
- ▶ 73" Sky-Rise Sleeper

### Axle Configurations

- ▶ 4x2
- ▶ 6x2
- ▶ 6x4

### Frames

- ▶ Heat Treated Alloy Steel 120,000 PSI

### Engines

- ▶ International A26 12.4L
  - 400 - 475 HP
  - 1,450 - 1,750 lb.-ft.
- ▶ Cummins X15 15L
  - 400 - 565 HP
  - 1,450 - 2,050 lb.-ft.

### Transmissions

- ▶ Automated Manual Transmissions
  - Eaton Endurant: 11, 12 speed
  - Eaton Fuller UltraShift PLUS: 13, 18 speed
  - Eaton Fuller Advantage: 10 speed
- ▶ Manual Transmissions
  - Eaton Fuller Advantage: 10 speed
  - Eaton Fuller: 10 speed
  - Fuller: 9, 10, 13, 18 speed

### Front Axles

- ▶ Hendrickson: 12,000 - 14,000 lbs.
- ▶ Dana Spicer: 12,000 - 14,000 lbs.
- ▶ Meritor: 12,000 - 14,000 lbs.

### Front Suspension

- ▶ Spring Monoleaf: 12,000 - 13,200 lbs.
- ▶ Parabolic Taperleaf: 12,000 - 14,000 lbs.

### Single Rear Axles

- ▶ Meritor: 23,000 lbs.
- ▶ Dana Spicer: 23,000 lbs.

### Tandem Rear Axles

- ▶ Meritor: 40,000 - 46,000 lbs.
- ▶ Dana Spicer: 40,000 - 46,000 lbs.

### Rear Suspensions

- ▶ AIR SINGLE
  - International: 20,000 lbs.
  - International: 23,500 lbs. Vari-rate spring
- ▶ AIR TANDEM
  - International: 40,000 lbs.
  - Hendrickson: HTB 40,000 lbs.
  - Hendrickson: HAS 40,000 or 46,000 lbs.

### Brakes

- ▶ Air Disc Brakes with Automatic Traction Control and Electronic Stability Control
- ▶ Air Drum Brakes with ABS with Optional Automatic Traction Control and Electronic Stability Control

### Interiors

- ▶ Two Trim Levels:
  - Classic or Diamond
- ▶ Optional Black Cherry Accent Package available with Diamond Level Trim



**TAILOR THE LT SERIES TO SUIT YOUR DRIVER  
AND FIT YOUR BUSINESS.**



**CAB FEATURES**

Cab Trim Panels

Door Trim

Trim Inserts

Instrument Panel

Gauge Cluster

Accent Color

Sun Visors

Lighting

Window Controls

Lock Controls

Cup / Bottle Holders

Overhead Console

USB Accessory Port

**CLASSIC**

Easy to Clean Soft Touch Vinyl

Easy to Clean Soft Touch Vinyl

Neutral

Black

8-gauge, 3.5" Display with Odometer and Trip  
Optional: Premium 8-Gauge, 5" Color Display with Virtual Gauges

Neutral

Two

LED

Power

Manual or Power

Four

Molded Plastic with Retainer Nets and CB Radio Housing and  
Paper Towel Storage in Sleeper Configuration

Up to 4

**DIAMOND**

Easy to Clean Soft Touch Vinyl

Available with Black Cherry Accents - Padded Gray or Black Cherry  
Soft Touch Panels

Woodgrain - Optional Black Cherry Door Toppers

Black

8-gauge, 3.5" Display with Odometer and Trip  
Optional: Premium 8-Gauge, 5" Color Display with Virtual Gauges

Neutral - Optional Black Cherry

Two

LED

Power

Power

Four

Molded Plastic with Retainer Nets and CB Radio Housing and  
Paper Towel Storage in Sleeper Configuration

Up to 4



# TRIM LEVEL FEATURES/AVAILABILITY

## SLEEPER FEATURES

12 Volt Power Supply

## CLASSIC

Standard

## DIAMOND

Standard

Trim Panels

Easy to Clean Soft Vinyl Neutral Trim Panels

Easy to Clean Soft Vinyl Trim Neutral or Available Black Cherry Accents with Woodgrain Inserts

Headliner

Soft Vinyl

Soft Vinyl

Sleeper Windows

Standard

Standard

Windshield Curtain

Optional

Optional

Sleeper Control Panel

Standard

Standard

Microwave Accommodation

Optional

Optional

TV Accommodation

Optional

Optional

### 56" Low Roof Sleeper Features

Overhead Storage

Two Airline Style Cabinets standard, with an Option for Two Additional

Two Airline Style Cabinets Standard, with an Option for Two Additional

### 56" Hi-Rise Sleeper Features

Overhead Storage

Two or Four Compartments with Netting

Two Compartments with Netting or Doors

Rear Wall Storage

Optional

Optional

### 73" Hi-Rise Sleeper Features

Overhead Storage

Optional Two or Four Compartments with Nets or Optional Doors

Optional Two or Four Compartments with Nets or Optional Doors

Rear Wall Storage

Optional

Standard

Driver Side Wardrobe

Standard, Optional Doors

Standard, Optional Doors

Passenger Side Cabinets

Utility Cabinet, Lower Right Wardrobe Tower Cabinet, Dresser Cabinet, Refrigerator Storage With or Without Doors

Utility Cabinet, Lower Right Wardrobe Tower Cabinet, Dresser Cabinet, Refrigerator Storage With or Without Doors

### 73" Sky-Rise Sleeper Features

Overhead Storage

Two Compartments with Nets

Two Compartments with Nets

Rear Wall and Upper/Lower Storage

Standard

Standard

Driver Side Cabinets

Standard Lower and Upper Storage with Shelves, Nets or Optional Doors

Standard Lower and Upper Storage with Shelves, Nets or Optional Doors

Passenger Side Wardrobe

Standard Cabinet Tower Wardrobe and Optional Door, Shelves and Net

Standard Cabinet Tower Wardrobe and Optional Door, Shelves and Net



## A REVOLUTION IN FLEET SERVICE MANAGEMENT

International® 360, a ground-breaking service communication and fleet management platform that can help you manage your entire portfolio of assets with ease while enabling streamlined, transparent communication with dealerships and more efficient fleet operations.

### BOOSTING UPTIME AND LOWERING TOTAL COST OF OWNERSHIP.

International 360 is built to transform your service process and revolutionize how you manage the utilization of your assets:

- ▶ Seamless communications with dealers and up-to-date repair status visibility
- ▶ Complete VIN-based information – asset specs, complete parts catalog, available service information, even remote diagnostics and health data
- ▶ Instant online service request initiation and estimate approvals
- ▶ Complete service history, up-to-date campaign information, and engine calibration status

# INTERNATIONAL® 360

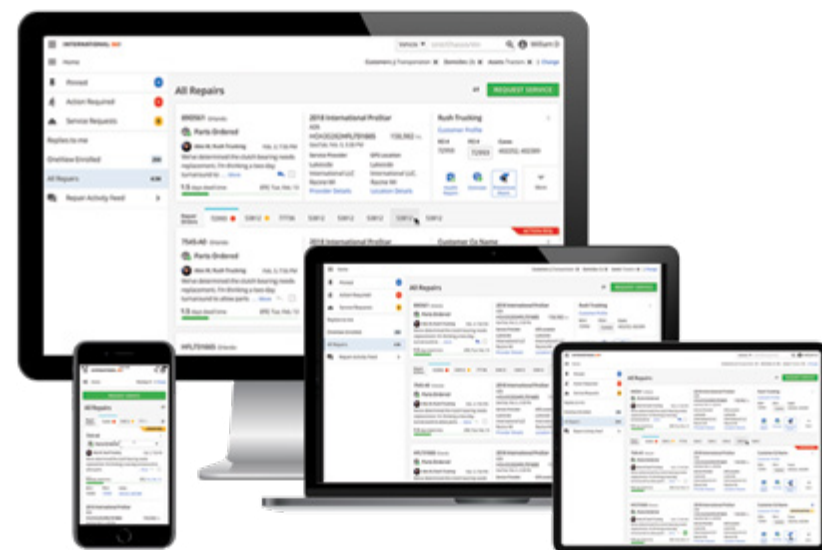

## OnCommand® Connection

### REMOTE DIAGNOSTICS FOR ALL MAKES OF VEHICLES.

All LT® models come equipped with OnCommand Connection telematics and a free two-year subscription to our Advanced Remote Diagnostics solution.



### ALL THE TOOLS YOU NEED AT YOUR FINGERTIPS

OnCommand® Connection is designed to keep your vehicles moving and your profits rising through powerful features such as **interactive mapping**, **engineer-designed action plans** and **access to your fleet health information** through our portal or customized reporting to your email inbox.

### OnCommand® Connection Features:



#### Customizable Dashboard

Easily track vehicle location data, vehicle health status, and more to stay fully informed on your fleet



#### Vehicle Health Reports

Detailed history and health information on every vehicle, including fault code history, engine status, fluid levels and more



#### Live Fault Code Action Plans (FCAPs)

Simple fault code descriptions, rating of fault severities and recommended actions to address the issue to help you prioritize which vehicles need repairs and keep your fleet running at peak performance



#### Geofencing

Set up designated areas and generate reports on which vehicles are inside and outside of those areas



Navistar Capital is an industry leader in commercial vehicle financing with over 40 years of experience. We provide customized leases and secured loans with flexible structuring for International heavy and medium duty commercial vehicles. Contact your local International Truck dealer for more information.



Fleetrite is the first name recognized for trusted quality in aftermarket truck and bus parts. With 50 years of strong performance in the industry, Fleetrite parts are OEM aftermarket quality approved and are backed by a one-year nationwide parts and labor warranty. High-quality parts at a competitive price. It's the reason why it's always the first recommended by more than 700 International Truck and IC Bus dealers. Your uptime is our first priority. Ask for Fleetrite First.



**TOP OF THE LINE. TOP OF MIND.**



**WE HAVE YOUR BACK SO YOU CAN KEEP MOVING FORWARD**

Your International dealer is one of the best in the business, and a strong link in the industry's broadest, most capable parts distribution and dealer network.



**DIAMOND EDGE<sup>SM</sup> CERTIFIED INTERNATIONAL TRUCK DEALERS**

This select network of International dealer service departments has passed rigorous parts and service certification guidelines to provide you with faster turnarounds, immediate parts availability and a higher level of servicing expertise. Their ongoing pledge is to maximize your uptime and deliver a best-in-class customer experience.

**LESS LOST DAYS. MORE OPEN BAYS.**

We've also increased your access to more service locations with our Love's & Speedco partnership. Over 300 locations are International Truck Certified Service Partners, factory-trained and authorized to perform warranty work for International Truck Class 6 through 8 trucks to get you back on the road quickly, maximizing uptime.\*

**YES, WE'RE OPEN**

**Saturday**  
**830**  
Locations

**Sunday**  
**389**  
Locations

**10,786+**  
TECHNICIANS



**8,625+**  
SERVICE BAYS

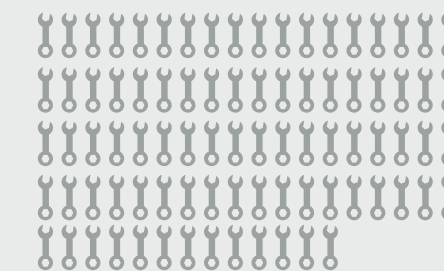

So no matter where you drive, you're not far from one of our

**1,055**  
DEALER LOCATIONS

Leading all competitors in

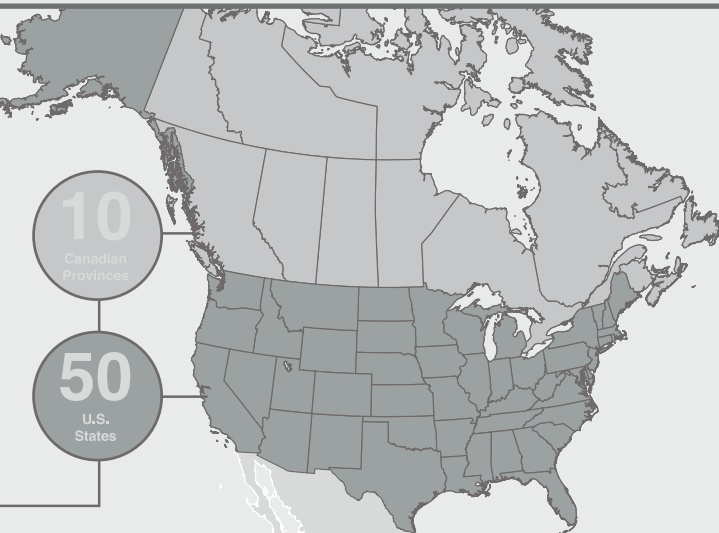

\*Love's and Speedco locations in Texas cannot perform warranty services.





**Note:** The information and conclusions contained herein are believed to be correct at time of publication, but do not necessarily apply to similar vehicles with different specifications or with production dates after the production of this publication. Vehicles with different specifications or later dates of production may yield different results. Vehicle specifications are subject to change without notice. TAD16013 10/2019 ©2019 NAVISTAR Inc. All rights reserved. All marks are trademarks of their respective owners.